

Varenummer: 392211008053516
 Beskrivelse: Snekkegear med skridnav
 W110 L1-UFC-80-P90 B5

Mål

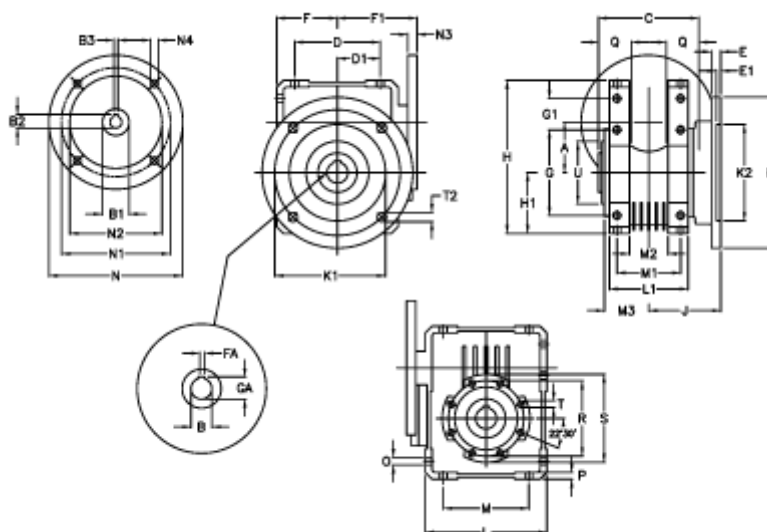

A = 110.10	E = 20	H = 308.0	M = 184	N4 = M10x12	U = 130
B = 42	E1 = 12	H1 = 125.0	M1 = 115	O = 14.0	
B1 E7 = 24	F = 125	J = 131.5	M2 = 69	P = 14	
B2 = 27.3	F1 = 143	K = 280	M3 = 73.0	Q = 45	
B3 H9 = 8	FA = 12	K1 = 230	N = 200	R = 165	
C = 155	G = 184	K2 = 170	N1 = 165	S = 200	
D = 174.0	G1 = 58.0	L = 250	N2 = 130	T = M12x19	
D1 = 82.0	GA = 45.3	L1 = 143	N3 = -	T2 = 13.0	